

RESTRICTED
FILE: O

TECHNICAL ORDER NO. 01-140DA-1

PILOT'S FLIGHT OPERATING INSTRUCTIONS

•

L-4A and L-4B AIRPLANES



NOTICE: This document contains information affecting the National Defense of the United States within the meaning of the Espionage Act, 50 U. S. C., 31 and 32, as amended. Its transmission or the revelation of its contents in any manner to an unauthorized person is prohibited by law.

PUBLISHED BY AUTHORITY OF THE COMMANDING GENERAL,
ARMY AIR FORCES, BY THE HEADQUARTERS,
AIR SERVICE COMMAND, PATTERSON FIELD, FAIRFIELD, OHIO

LIST OF REVISED PAGES ISSUED

Page	Latest Revised Date
3.....	4-10-43
10.....	4-10-43

NOTE: A heavy black vertical line, to the left of the text on revised pages, indicates the extent of the revision. This line is omitted where more than 50 percent of the page is revised.

**THIS PUBLICATION MAY BE USED BY PERSONNEL RENDERING
SERVICE TO THE UNITED STATES OR ITS ALLIES**



Paragraph 5.d. of Army Regulation 380-5 relative to the handling of "restricted" printed matter is quoted below.

"d. Dissemination of restricted matter.—The information contained in restricted documents and the essential characteristics of restricted material may be given to any person known to be in the service of the United States and to persons of undoubted loyalty and discretion who are cooperating in Government work, but will not be communicated to the public or to the press except by authorized military public relations agencies."

This permits the issue of "restricted" publications to civilian contract and other accredited schools engaged in training personnel for Government work, to civilian concerns contracting for overhaul and repair of aircraft or aircraft accessories, and to similar commercial organizations.

TABLE OF CONTENTS

<u>Section</u>	<u>Page</u>	<u>Section</u>	<u>Page</u>
I	Description		
	1. General Description	12. Stalls	11
	2. Flight Personnel	13. Spins	11
	3. Interior of the Cockpit	14. Diving	11
	a. The Emergency Equipment	15. Emergency Exit	11
	b. The Instrument Panel	16. Approach, Landing, and Cross-wind Landing	11
	c. The Right Side	17. Emergency Take-off if Landing Is Not Completed	11
	d. The Upper Left Side	18. Stopping of Engine	11
	e. The Lower Left Side	19. Check Before Leaving the Cockpit	12
	f. The Observer's Desk	20. Maneuvers Prohibited	12
	g. The Floor		
	h. The Fuel System	III Flight Operation Data	13
	i. The Lubricating System		
II	Pilot Operating Instructions	IV Operational and Electrical Equipment (Model L-4A Only)	18
	1. Review of Information	1. Communication Equipment and Operation	18
	2. Entering the Cockpit	a. The Communication Equipment	18
	3. Starting Engine	(1) Radio Receiver	18
	4. Engine Warm-up	(2) Transmitter System	18
	5. Check-off List Before Taxying	(3) Antenna System	18
	6. Taxying Instructions	b. Operation	18
	7. Take-off	2. Electrical Equipment	19
	8. Climb		
	9. Flight Operation	APPENDIX I Abridged United States- British Glossary of Nomen- clature	20
	10. General Flying Character- istics		
	11. Engine Failure During Flight		

ILLUSTRATIONS

<u>Figure</u>		<u>Page</u>
1	The Model L-4A in Flight	2
2	The Model L-4B in Flight	2
3	Top, Side, and Front Views of the Model L-4A	3
4	Top, Side, and Front Views of the Model L-4B	3
5	Engine of the Model L-4A or L-4B	4
6	Emergency Equipment on the Model L-4A	4
7	Emergency Equipment on the Model L-4B	4
8	Instrument Panel on the Model L-4A	5
9	Instrument Panel on the Model L-4B	5
10	Right Side of the Model L-4A or L-4B (Interior of Cockpit)	5
11	Upper Left Side of the Model L-4A (Interior of Cockpit)	5
12	Upper Left Side of the Model L-4B (Interior of Cockpit)	6
13	Lower Left Side of the Models L-4A and L-4B (Interior of Cockpit)	6
14	Observer's Desk in the Model L-4A	6
15	Observer's Desk in the Model L-4B	6
16	Cockpit Floor in the Model L-4A	7
17	Cockpit Floor in the Model L-4B	7
18	Fuel System in the Models L-4A and L-4B	8
19	Oil System in the Models L-4A and L-4B	8
20	Hydraulic System in the Models L-4A and L-4B	8
21	Weight and Balance Diagram for the Models L-4A and L-4B	13
	Weight and Balance Chart (Model L-4A)	14
	Weight and Balance Chart (Model L-4B)	15
	Specific Engine Flight Chart (Models L-4A and L-4B)	16
	Take-off, Climb, and Landing Chart (Models L-4A and L-4B)	17
22	Interconnection Diagram of the Model L-4A Aircraft Communi- cation System	19



Figure 1 -
The Model
L-4A
in Flight



Figure 2 -
The Model
L-4B
in Flight

SECTION I

DESCRIPTION

1. General Description.

a. The models L-4A and L-4B Airplanes, manufactured by Piper Aircraft Corporation, Lock Haven, Pa., under contract W535 ac-24952 and ac-30126, are light monoplanes with high wings, externally strut-braced, with no wing flaps. The L-4B is similar to the L-4A, except that no radio or electrical equipment is installed. Provision is made, however, for a portable radio. The fuselage is a welded steel tubular framework, fabric-skinned. It is provided with seats for two crew members in tandem. The landing gear is of the fixed split-vee type, consisting of individually sprung wheels on which are mounted low pressure 8.00-x4-inch tires. The steerable tail wheel is mounted on steel spring leaves. Its solid rubber tire is 6 x 2.00 inches. The cockpit enclosure is covered with transparent sheets on the top and sides, from the windshield to a point approximately thirty inches aft of the wing trailing edge. (See figures 1, 2, 3, and 4.) The tactical mission of these airplanes is making short-range reconnaissance trips and acting as liaison agents for the use of ground commanders.

b. The airplanes are powered by one Continental A65-8 (AAF designation O-170-3) engine mounted in the nose. (See figure 5.) They

are air cooled, with four horizontally opposed cylinders and overhead valves. The normal horsepower rating at sea level is 65 and the rpm 2300. The lubricant is admitted to the sump through the oil filler cap on the right side of the engine behind the cylinders (figure 5). The fuel tank, with a capacity of 12 U.S. gallons (10 Imperial gallons), is located in the fuselage just behind the fire wall. The fuel is admitted to the tank through the fuel tank cap just ahead of the windshield on the outside. Attached to and penetrating the cap is the fuel gage. It is of the float type, not calibrated, the extended end showing the proportion of fuel supply remaining. The pilot can readily observe the gage from the cockpit through the windshield (figure 5).

c. The propeller is directly driven, having two fixed-pitch wooden blades. It has a diameter of 6 feet and a ground clearance of 1 foot and 2-1/2 inches in level flight position.

2. Flight Personnel.

The cockpit provides two seats in tandem, with each person having a complete set of con-

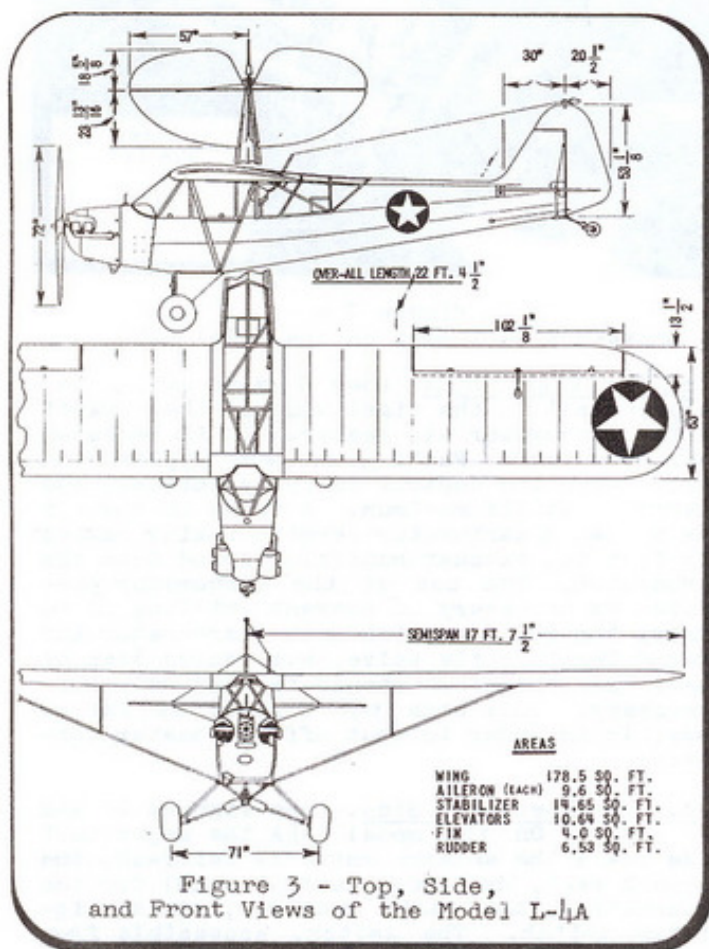

Figure 3 - Top, Side, and Front Views of the Model L-4A

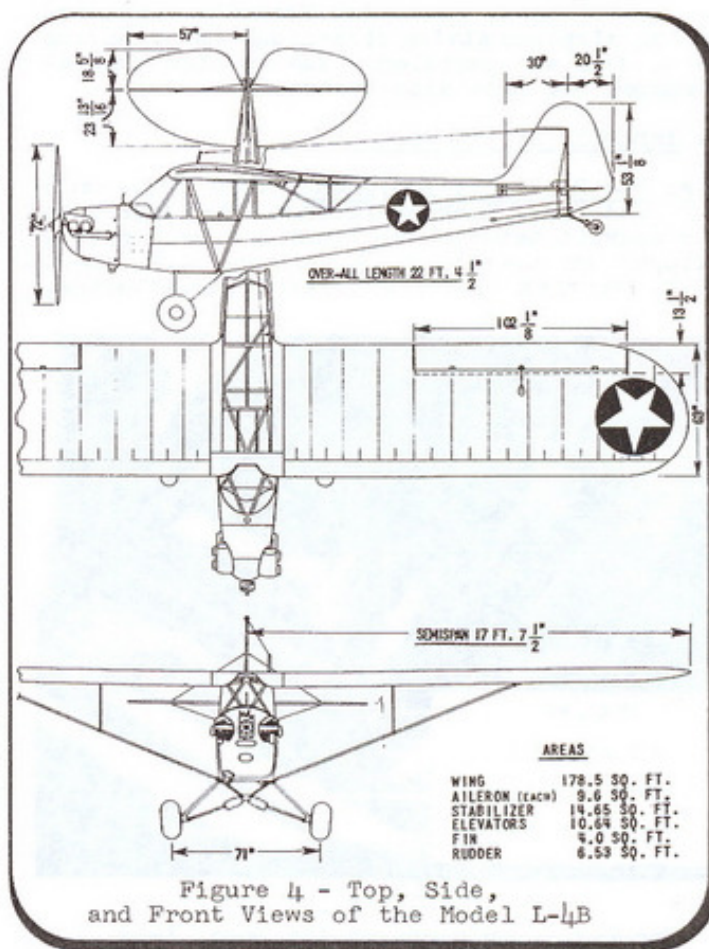

Figure 4 - Top, Side, and Front Views of the Model L-4B

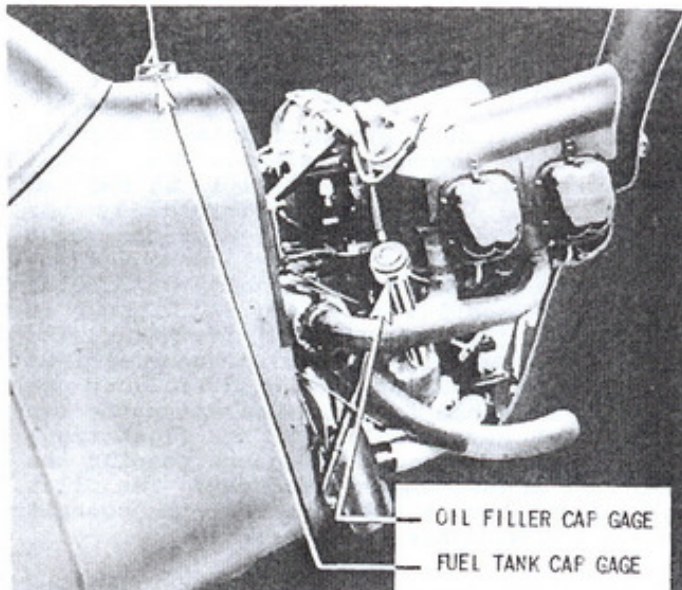

Figure 5 -
Engine of the Model L-4A or L-4B

trols. The instrument panel is so arranged that the instruments are visible from either seat and visibility is very good from either front or rear seat in a flight or landing attitude. The rear seat is so placed that occupant can face forward (operating airplane) or aft (observing). This alternative is determined before flight is started. There is a placard in the airplane giving directions for removing stick for aft position. The cushion is rearranged for this alternative.

3. Interior of the Cockpit.

a. The Emergency Equipment. (See figures 6 and 7.) - Looking through the door into the cockpit between the front and back seats, clipped to the floor is the one U.S. quart (0.8 Imperial quart), carbon tetrachloride,

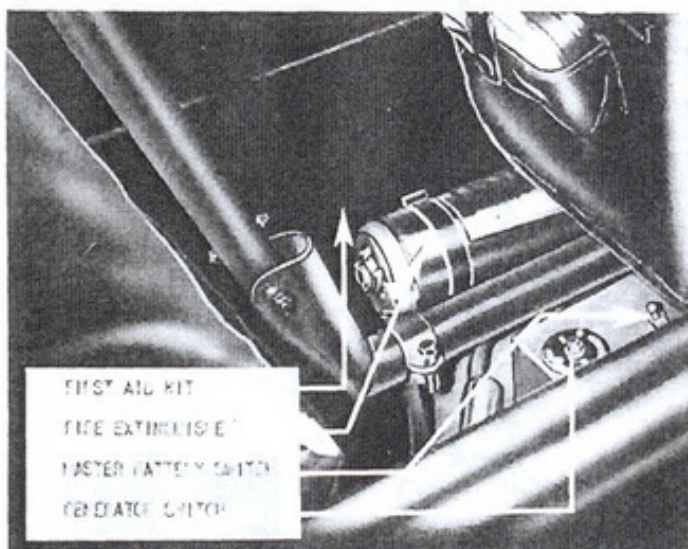

Figure 6 -
Emergency Equipment on the Model L-4A

hand fire extinguisher, easily removed with a quick upward movement after releasing safety catch. The first aid kit is located in the upholstery pocket in the back of the front seat. Back-type parachutes may be worn in the front and rear seats by removing the seat-back cushions. In case exit is not possible through the door, the small window on the left side, which slides down, may be used.

b. The Instrument Panel. (See figures 8 and 9.) - This panel, located in front of the pilot, contains a battery condition indicator (model L-4A only), tachometer, air-speed indicator, compass, deviation card, altimeter, oil temperature and oil pressure gages, primer knob, and cabin heater knob. An air heater muff surrounds the exhaust silencer and is used to furnish warm air to the cabin. Ventilation is accomplished by adjustment of the sliding window on the left side.

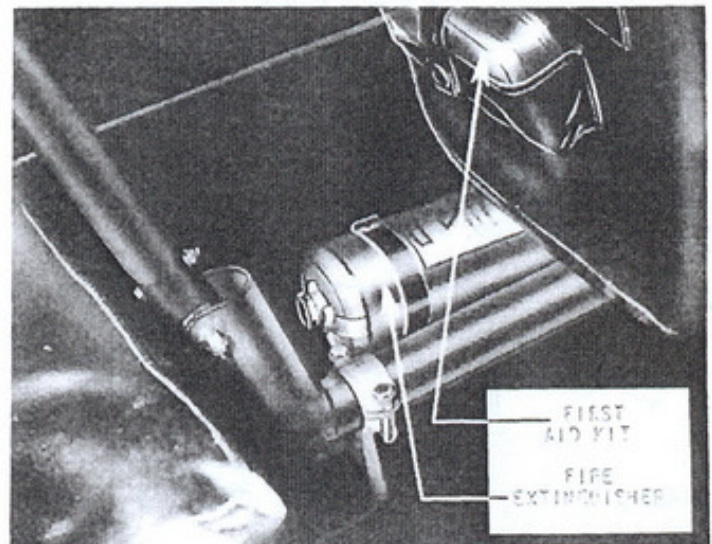

Figure 7 -
Emergency Equipment on the Model L-4B

c. The Right Side. (See figure 10.) - The only control on the right side of the cockpit is the carburetor air heater. It is recessed near the door. Pushing forward applies the heat. When the control is fully forward, the heater is at its maximum. A valve in the air box below the carburetor permits taking heated air from the exhaust manifold shroud into the carburetor. The use of the carburetor pre-heater is necessary to prevent chilling or to remove the ice formation in the carburetor and around the throttle valve, but causes loss of power and therefore should be used only when necessary. Pull back the control as far as possible in order to shut off the heater completely.

d. The Upper Left Side. (See figures 11 and 12.) - On the model L-4A the upper left side bears the antenna entrance fairlead, the antenna reel, the remote control panel for the transmitter, the radio receiver, and the ignition switch. The switch, accessible from

both seats, permits the use of either magneto separately, or both together. On the model L-4B the only control on the upper left side is the ignition switch.

e. The Lower Left Side. (See figure 13.) - The throttles are dual quadrant levers along the window ledge. The fuel shut-off control is recessed. Push forward for "ON" and pull backward for "OFF." It operates the fuel shut-off cock directly beneath the gas tank. The stabilizer adjustment control, by means of a cranking action, causes a worm gear in the stabilizer assembly to raise or lower the leading edge of the horizontal stabilizer, correcting for various flight or load conditions. A visual indicator button above the crank is provided which shows the position of the stabilizer.

f. The Observer's Desk. (See figures 14 and 15.) - The desk is aft in the cockpit. The observer has visibility above and on all

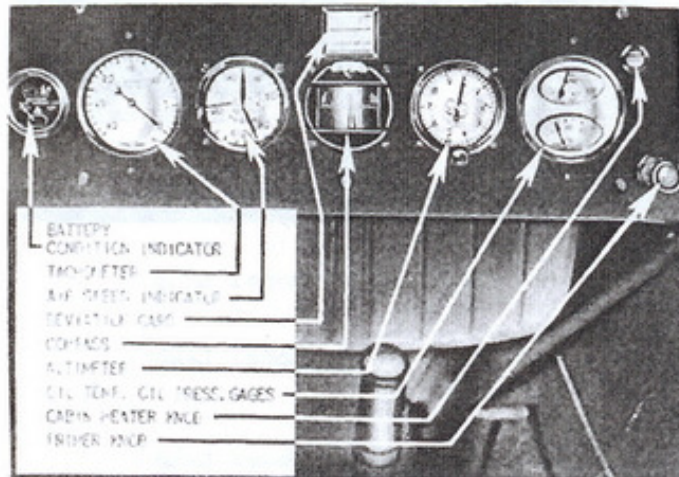

Figure 8 -
Instrument Panel on the Model L-4A

sides. On the desk is the radio transmitter and two cards, the operating instructions and the tuning chart (model L-4A only). Along the edge are the control stick clips which furnish stowage for the rear stick when removed for aft observation. Underneath the desk along the right side is the map rack. On the ceiling is the portable radio lead-in bushing (model L-4B only).

g. The Floor. (See figure 16.)

(1) Conventional dual rudder pedals which operate the rudder are fairly simple. See that rudder pedal return springs are operating to bring the pedal back in position when foot pressure is relinquished. The dual brake pedals are of the heel type, located beneath the rudder pedals. They are individually actuated and of the hydraulic type. Pressure applied by the pilot impedes or stays the turning motion of the wheels. (See figures 16, 17, and 20.) The pedals are mounted on a bearing shaft which is located under the floor. (See figure 20.) Pressure on the pedal is transmitted through

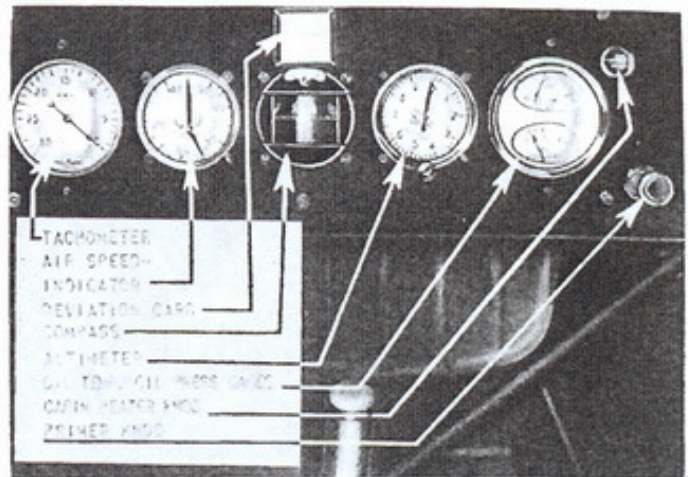

Figure 9 -
Instrument Panel on the Model L-4B

a push rod to a master cylinder filled with oil. This is connected to the brake drum by a copper tube.

(2) The metal battery box is located on the floor just aft of the fire wall (model L-4A only). The battery is provided with master fuses and spares. The conventional dual control sticks operate the elevators and ailerons. Aft of the front seat to the right of the torque tube is located the switch box (model L-4A only) containing the master and generator switches. (See figures 6 and 16.) These controls have no relation to the power plant. Aft of the front seat to the left of the torque tube is the fire extinguisher. (See figures 6, 16, and 17.)

h. The Fuel System. (See figures 8, 9, 13, and 18.) - The fuel system is composed of one 12 U.S. gallon (10 Imperial gallon) gasoline tank, primer, throttle control, fuel

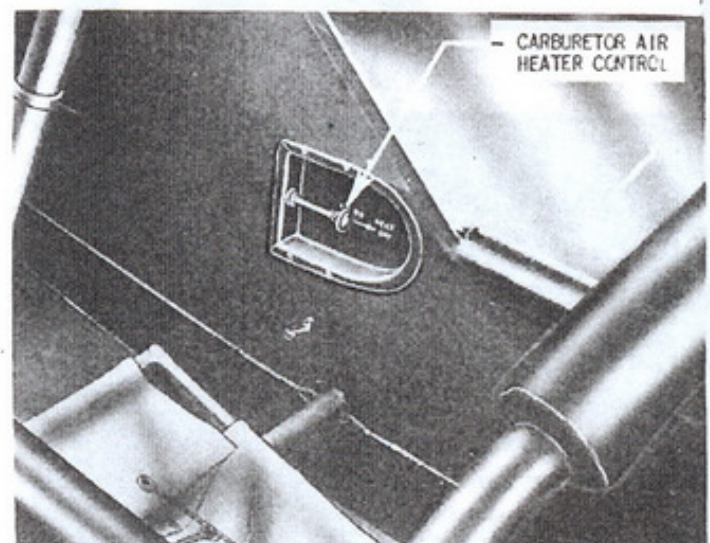
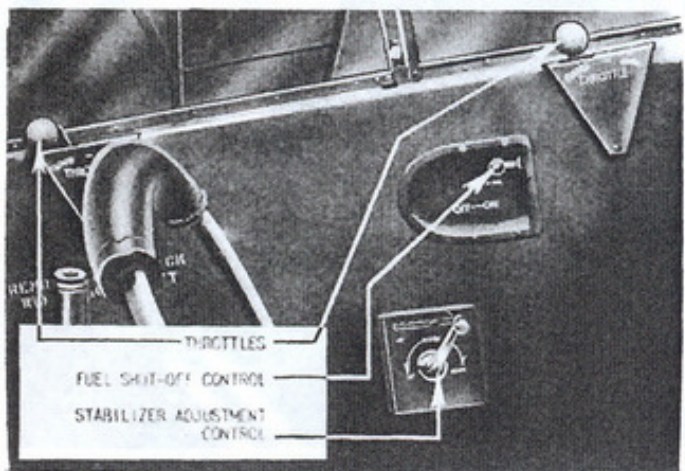
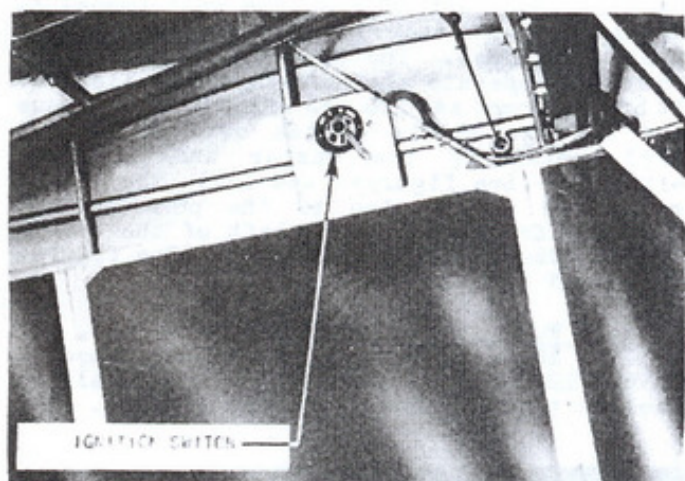
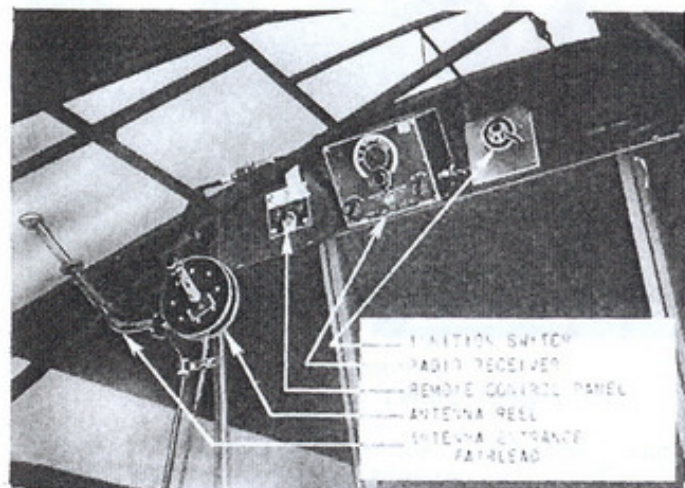

Figure 10 - Right Side of the
Model L-4A or L-4B (Interior of Cockpit)

shut-off control, fuel valve, and fuel line to strainer and thence to carburetor. Use fuel grade of 73 octane minimum.

1. The Lubricating System. (See figures 5, 8, 9, and 19.) - The lubrication of the



power plant is internal. The only external features are the oil pressure and oil temperature gages, oil filler, oil filler neck, and one U.S. gallon (0.8 Imperial gallon) oil tank or sump.

Figure 11 -
Upper Left Side of the Model L-4A
(Interior of Cockpit)

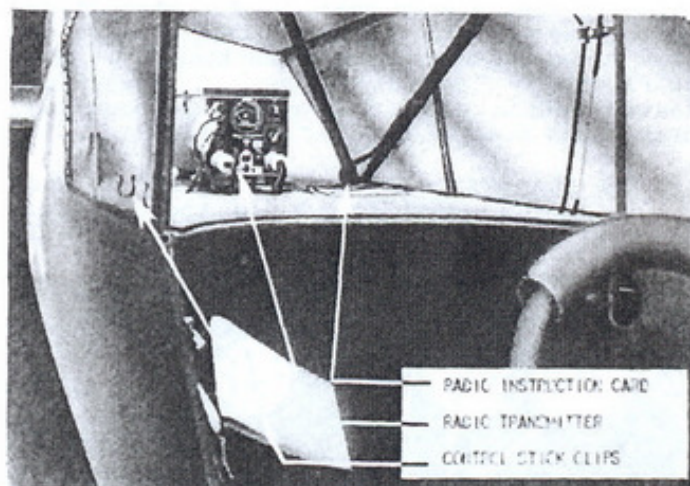

Figure 14 -
Observer's Desk in the Model L-4A

Figure 12 -
Upper Left Side of the Model L-4B
(Interior of Cockpit)

Figure 15 -
Observer's Desk in the Model L-4B

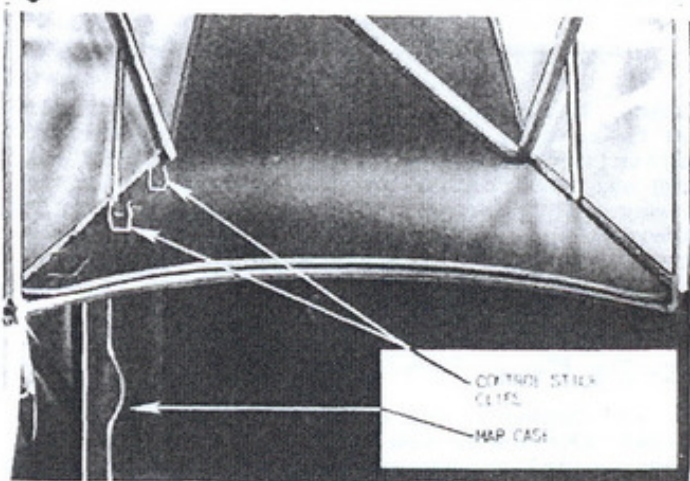

Figure 13 -
Lower Left Side of the Models L-4A
and L-4B (Interior of Cockpit)

SECTION II

PILOT OPERATING INSTRUCTIONS1. Review of Information.

a. The model L-4A and L-4B airplanes may be taken off, flown, and landed in the manner of all conventional airplanes of this type. (See figures 1 and 2.) The flying characteristics of the airplanes are normal in all respects, there being no special features incorporated that would require special attention.

b. Having an over-all span of 35 feet 2-1/2 inches over-all length of 22 feet 4-1/2 inches, over-all height at rest 6 feet 8 inches, wing loading of 6.5 pounds per square feet, and power loading of 17.84 pounds per horsepower, the L-4A and L-4B are in the category of so-

called "light airplanes." (See figures 3 and 4.) As such they present some problems to the pilot who is familiar only with heavier and more powerful aircraft. The stalling speed fully loaded is 38 mph, and the gliding ratio of nine to one indicates that the airplanes have a flat, slow glide. Care should be exercised by the pilot unfamiliar with this type of airplane, since the slow landing speed and glide may easily deceive a pilot accustomed to much more speed.

c. The empty model L-4A airplane weighs about 740 pounds, and with fuel and oil, 820 pounds. The model L-4B weighs 693 pounds empty and 773 pounds with fuel and oil. The gross weight is

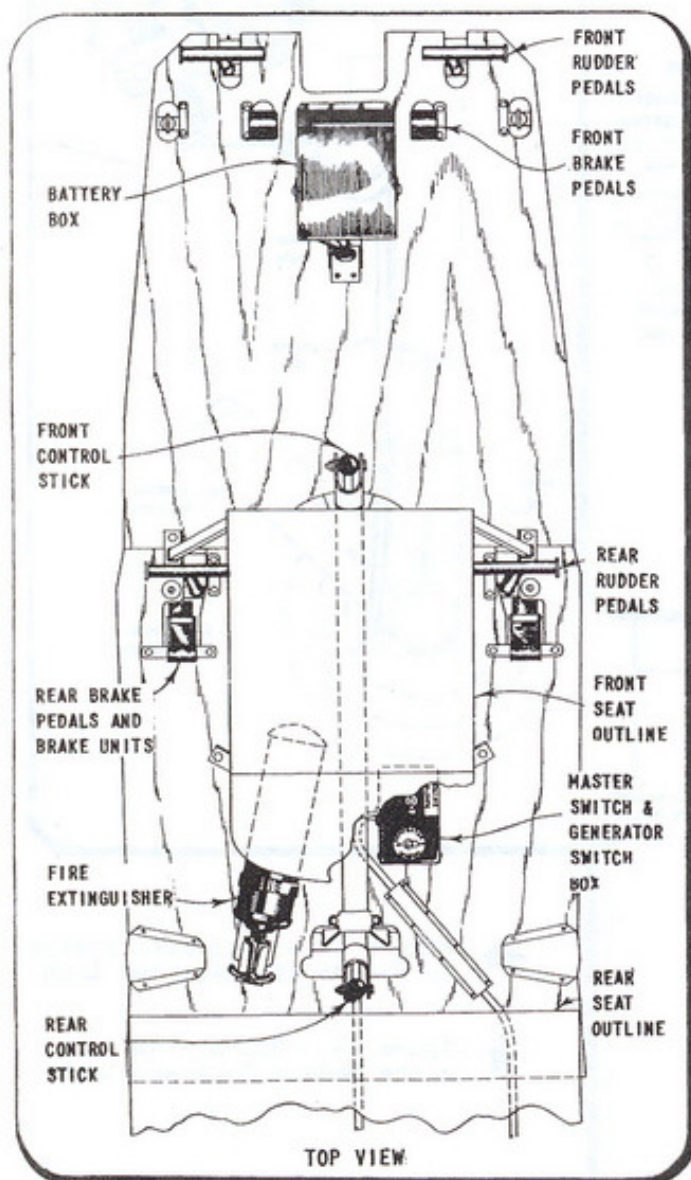

Figure 16 -
Cockpit Floor in the Model L-4A

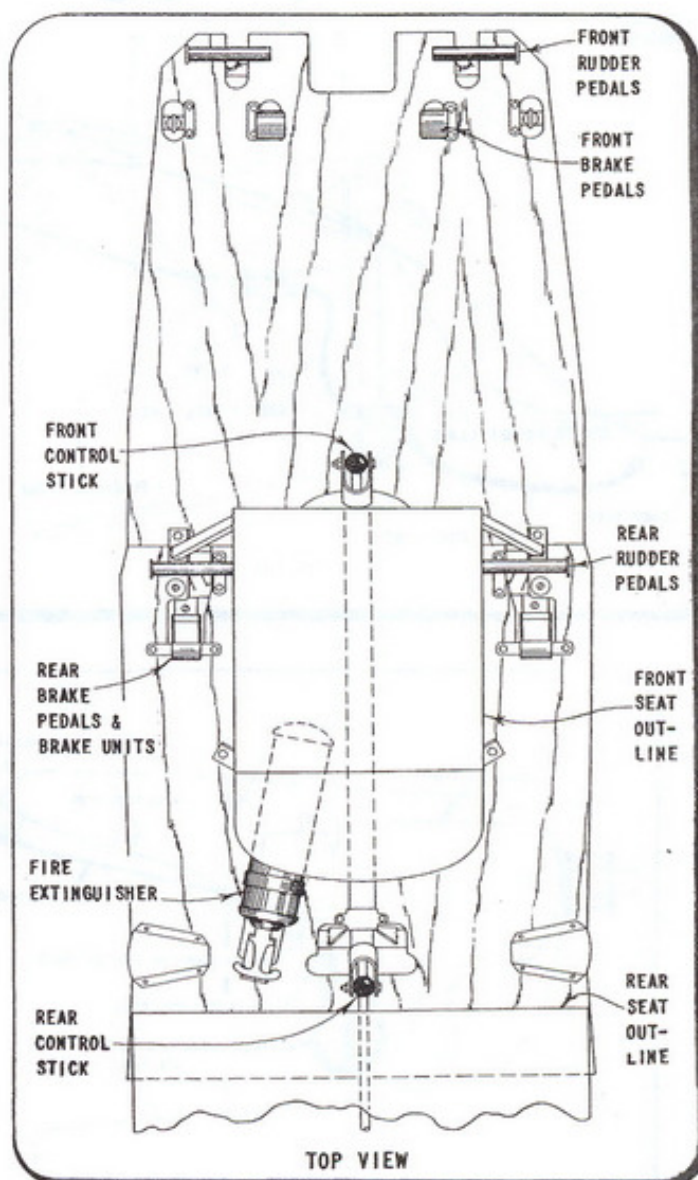

Figure 17 -
Cockpit Floor in the Model L-4B

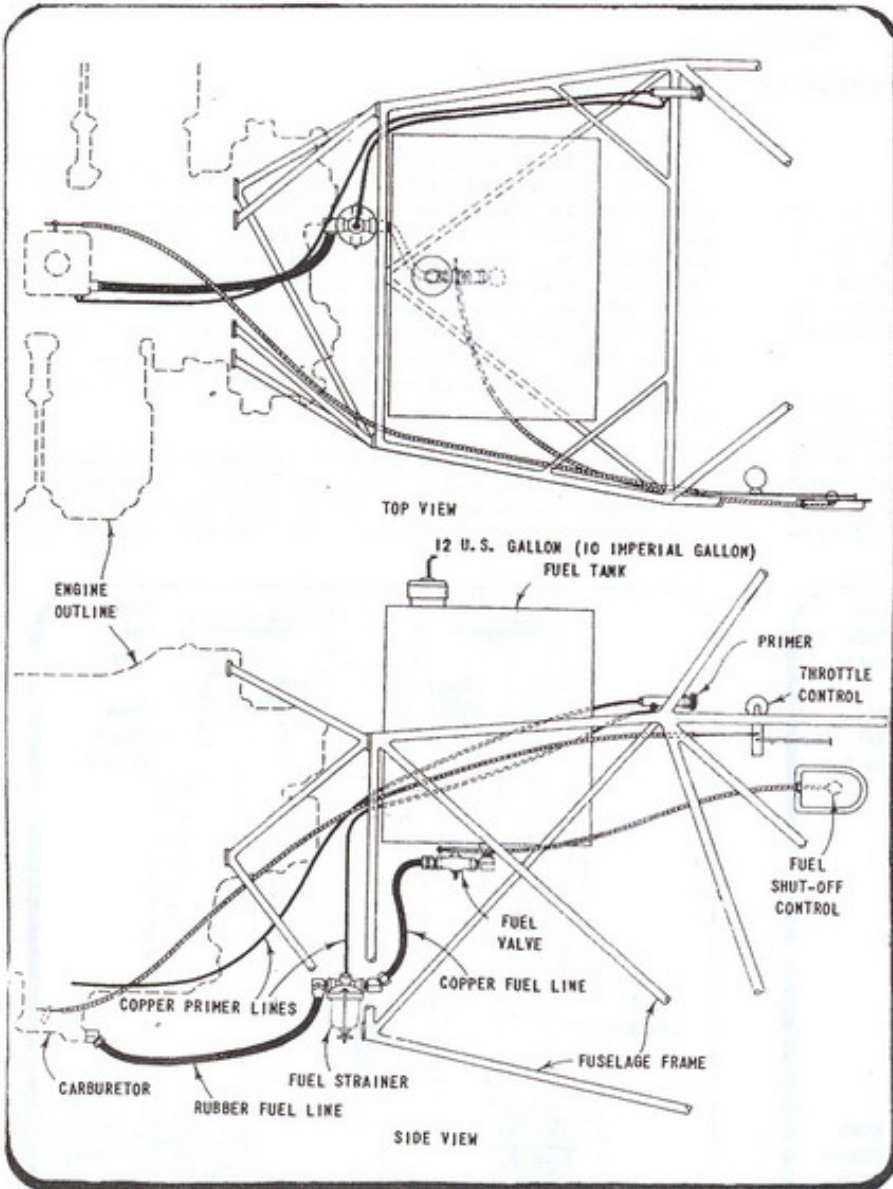

Figure 18 - Fuel System in the Models L-4A and L-4B

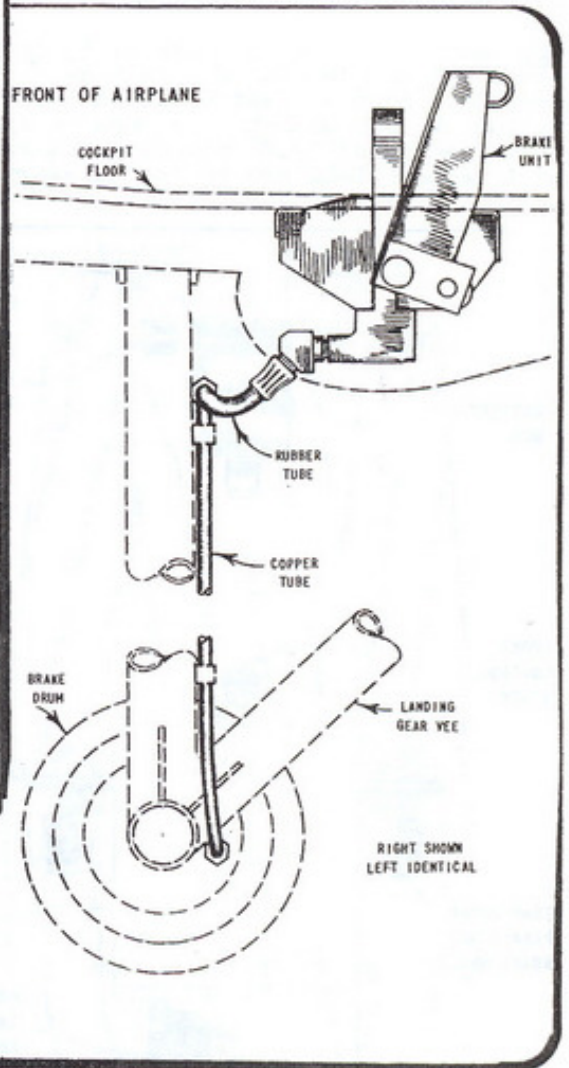
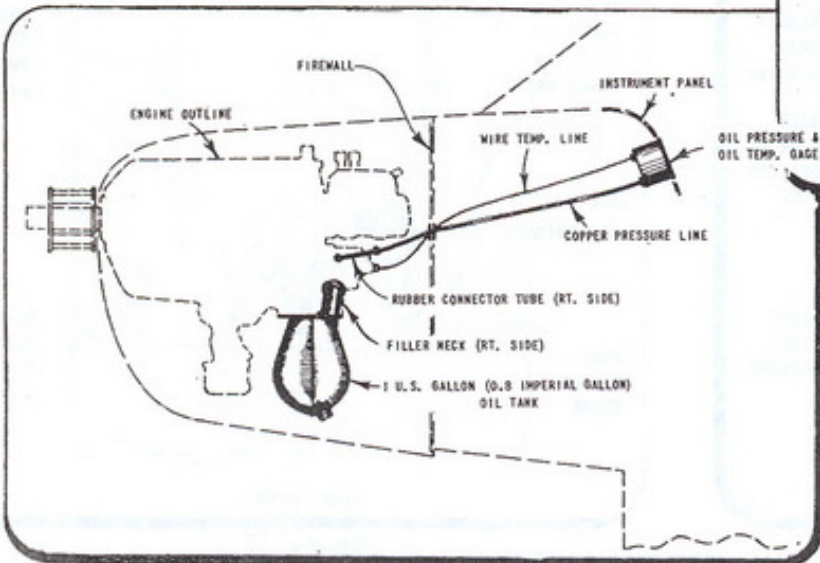

Figure 20 - Hydraulic System in the Models L-4A and L-4B

Figure 19 - Oil System in the Models L-4A and L-4B



1160 pounds with a useful load of 340 pounds (model L-4A) or 387 pounds (model L-4B) for crew, parachute, baggage, and observation equipment. (See figure 21 and the Weight and Balance Charts.) The 12 U.S. gallon (10 Imperial gallon) fuel tank represents the main feature of variable load. In case of solo flying the rear seat is used. Be sure to hook the unused safety belt. The center of gravity limits for both take-off and landing are 16.8 to 36 percent of the mean aerodynamic chord.

d. The airplanes are not provided with lights and are not intended for night-flying.

e. With 75 mph cruising speed and 12 U.S. gallons (10 Imperial gallons) of fuel, the cruising range is 206 miles.

2. Entering the Cockpit.

Entrance to the cockpit is made from behind, under the right wing. A step is suspended from the fuselage in the angle formed with the wing struts. A large door opens in two sections. The lower section is hinged along the lower edge and folds down. The upper section is hinged along the upper edge and folds up and out of the way. If the door is latched shut, it is necessary to open the window on the left side and reach across the cockpit to unlatch it.

3. Starting Engine.

a. Be sure the ignition switch is "OFF." (See figures 11 and 12.)

b. Set throttle slightly open. (See figure 13.)

c. Turn on fuel shut-off control. (See figure 13.)

d. Turn primer knob slightly to unlock. (See figures 8 and 9.) Pull out and push in slowly. Repeat three to five times to supply gas to carburetor.

CAUTION: Overpriming should be avoided to prevent the danger of washing lubricating oil from the cylinder walls. The carburetor is safety-wired in the full rich position. No priming is necessary if the engine is warm.

e. There is no starter. Have the mechanic turn the engine over by hand five or six times with the throttle still slightly open to make certain that combustion chambers are free of excess oil and draw fuel up through the idle system. A sucking noise should be heard in the carburetor.

CAUTION: From mechanic's position standing in front of the airplane, the propeller rotates counterclockwise. Be sure chocks are in front of wheels or that they are otherwise blocked. There are no parking brakes. The mechanic should be careful to stand firmly at as great a distance as possible. If necessary to

use both hands apply both to same blade. Do not overgrasp blade. Always treat propeller as if switch were "ON," even when cranking for priming, so that there will be no danger of being hit by propeller if it "kicks" or backfires or starts through a mistake.

f. Turn the ignition switch to "BOTH."

g. Start the engine by pulling propeller through with a snap.

h. If the engine fails to start, the above procedure should be repeated.

i. If the engine loads up, the ignition switch should be turned off, the throttle fully opened, and the engine turned backward to unload the cylinders.

j. In case of fire, cut off ignition and fuel at once. A hand fire extinguisher is located on the floor of the cockpit behind the front seat at the left. (See figures 6 and 7.)

4. Engine Warm-up.

a. As soon as the engine starts to fire, it is usually necessary to open the throttle slightly more to keep the engine running and to warm it up sufficiently for normal operation.

b. The speed should be maintained between 700 and 900 rpm and the oil pressure carefully observed. (See figures 8 and 9.)

c. If the gage fails to show oil pressure within 30 seconds after starting, stop the engine immediately and correct the trouble before continuing operation.

d. The throttle should not be opened wide until the oil has been warmed to within twenty degrees of normal operating temperature, which is a minimum of 120 degrees F (49 degrees C) and a maximum of 220 degrees F (104 degrees C). (See Specific Engine Flight Chart.)

e. The oil pressure should be 20 pounds per square inch minimum cruising, 35 maximum cruising, and 10 idling. (See Specific Engine Flight Chart.)

f. Continue the warming up procedure (700 to 900 rpm) for at least three to five minutes.

g. Emergency take-off may be made as soon as engine will take full throttle without missing.

h. Test each magneto individually. The engine speed should not drop off more than 50 rpm from dual magnetos.

CAUTION: Do not operate on either single magneto for more than thirty seconds at a time. Prolonged periods of operation at idling and full throttle while on the ground should be avoided.

5. Check-off List Before Taxying.

- a. Check for interference of controls.
- b. Be sure carburetor air heater is off. (See figure 10.)

CAUTION: Carburetor heat is used only under icing or near-icing conditions and is ordinarily unnecessary above 60 degrees F (10 degrees C). It means a loss of approximately 50 rpm.

c. Check airplane loading and adjust stabilizer accordingly with crank. (See figure 13.) It may be readjusted in the air.

d. Make sure that belt is on, door closed, and chocks removed.

e. The pilot new to this airplane is advised to ask for a check flight.

6. Taxying Instructions.

a. Increase throttle to put airplane in motion.

b. After inertia has been overcome, decrease throttle somewhat.

CAUTION: The tail of the model L-4A or L-4B is light. Taxying speed should not exceed the brisk walk of a person. Fast taxying is hazardous and causes unnecessary wear on the mechanism.

c. Since the airplane is provided with individually controlled hydraulic brakes and a steerable tail wheel, it is possible to make sharp turns by pivoting on either wheel. (See figure 20.)

7. Take-off.

a. The take-off distance in calm air, for full gross weight on hard dry surface to clear a 50-foot object is about 805 feet at sea level. (See Take-off, Climb, and Landing Chart.)

b. Use full throttle, headed straight into the wind, with wings level.

c. Move stick forward until tail rises.

d. When flying speed is attained, apply back pressure on stick for take-off.

e. Relax pressure to gain air speed of approximately 55 mph. (See Take-off, Climb, and Landing Chart.)

CAUTION: This speed is necessary as a precaution against engine failure. If the engine fails at this point, the airplane, being level, can settle for a forced landing.

8. Climb.

Reapply back pressure on stick for normal climb. Be sure to maintain speed of approximately 55 mph. The initial rate of climb is 450 feet per minute; to 5,000 feet in 14.4 minutes. (See Take-off, Climb, and Landing Chart.)

9. Flight Operation.

a. The engine should not be flown for any great length of time at full throttle (2300 rpm). The most satisfactory service may be obtained if the engine is cruised at a speed of 100-250 rpm below full throttle in level flight. (See Specific Engine Flight Chart.) 2200 rpm is safe but is done with certain penalties attached. The valve life will be appreciably shortened, as well as the piston ring and bearing life. There will be considerable sacrifice in gasoline and oil consumption. 2000 is the recommended cruising rpm, using approximately 4.27 gph. The cruising speed, full load, is 70 mph.

b. Should tachometer (figures 8 and 9) begin to fall unduly, push on carburetor air heater full (figure 10), as apparently the air entering the carburetor is too cool and moist and the carburetor may be icing. The tachometer should recover to approximately 50 rpm below normal. Then the carburetor air heater should be pushed off. If the troubling condition has been eliminated, the rpm will rise to normal. If not, repeat. It is more efficient to run the engine without the carburetor air heater. Therefore use only when absolutely necessary.

c. The oil temperature gage should not rise above 104 degrees C (220 degrees F). (See figures 8 and 9 and Specific Engine Flight Chart.)

d. The oil pressure gage should not fall below 20 pounds. (See figures 8 and 9 and Specific Engine Flight Chart.)

CAUTION: If c. and/or d. occur, a landing should be made without delay.

10. General Flying Characteristics.

a. The airplane is designed for observation, communication, and liaison purposes and should be maneuvered accordingly.

b. The stabilizer (figure 13) may be adjusted for load changes, thus maintaining trim throughout the flight.

c. The following maneuvers may be satisfactorily performed by a pilot experienced with the airplane:

- (1) Aileron or slow roll
- (2) Chandelle
- (3) Half roll or split S
- (4) Immelman turn
- (5) Loop
- (6) Normal spin
- (7) Normal stall
- (8) Snap roll or horizontal spin
- (9) Vertical bank (not to exceed 70 degrees)

CAUTION: Service ceiling for the L-4A and L-4B is 11,950 feet.

11. Engine Failure During Flight.

a. If the engine loses rpm because of icing, the carburetor air heater should be pushed fully on.

b. If the engine should stop completely, it may be possible to dive airplane in order to start the engine.

c. If engine will not start for any cause, such as exhausted fuel supply, prepare glide for forced landing. With a glide ratio of nine to one it is practical to figure a mile for each thousand feet of elevation until grounding.

12. Stalls.

The full-load stalling speed is 38 mph. In stalling there is a noticeable softening of aileron control. The airplane mushes with the tail low and then the nose drops, but a turn in either direction can be controlled by the rudder.

13. Spins.

For rapid recovery from an involuntary spin, the following sequence of operations should be followed:

a. Apply full opposite rudder.

b. Make one-quarter of a turn.

c. Push stick forward.

d. Alternative. - Recovery may also be effected by a simultaneous or reverse order of these operations, but the time or number of turns required to recover from the spin is greater than in the former case. During recovery the controls should be kept in the extreme righting position since slackening up results in slower, but still positive, recoveries.

14. Diving.

This airplane is not designed for diving but a steep glide can be taken in case of emergency. Speed limit is 122 mph. Apply carburetor air heater. Maximum permissible engine overspeed is 2530 rpm.

CAUTION: Do not dive in gusty air, nor make abrupt pull-outs.

15. Emergency Exit.

In case exit is not possible through the door, the small window on the left side may be used.

16. Approach, Landing, and Cross-wind Landing.

a. Push on carburetor air heater, if not on.

b. Glide at 60 mph. (See Take-off, Climb, and Landing Chart.) The slow glide ratio is nine to one.

c. Head into wind, with throttle slightly open, at approximately 600 feet altitude.

CAUTION: The rpm should not be reduced to less than 800 to 1000. The throttle should be left slightly open to prevent engine from cooling too rapidly.

d. (Optional) Set stabilizer to bring nose up.

e. When 10 to 15 feet from ground, break glide by a slight, continuous back pressure on stick.

f. Level off.

g. Ease stick as airplane settles.

h. Close throttle just before landing, engine idling.

i. Push stick fully back. A three-point landing may be made at 38 mph. Total distance from clearing 50-foot object to stop is about 605 feet. (See Take-off, Climb, and Landing Chart.)

j. Taxi back to flight line with as little use of brakes as possible because of the fact that braking requires considerably more throttle and wears the tires excessively.

k. Cross-wind Landing. - Since the airplane is light-weight and has a low wing loading, it is well to exercise a little extra care in cross-wind landing. Drop the upwind wing tip sufficiently to overcome the drift effect, stopping turning tendencies caused by this lowered wing with enough pressure on the opposite rudder. This is, in effect, a mild slip.

17. Emergency Take-off if Landing Is Not Completed.

Since the throttle has been left slightly open, the engine will be kept "clear" and ready for instant use should full throttle be needed because of overshooting or undershooting the field.

18. Stopping of Engine.

a. Never cut the ignition switch immediately after landing, as this tends to cool the engine too rapidly.

b. Close fuel supply.

c. Idle engine until the fuel runs out. This permits an even and slow cooling of parts.

d. At reasonable intervals the ignition switch should be changed from one magneto system to the other in order to reduce the temperature of the spark plug insulators. Switching from one set of plugs to the other overcomes the tendency of the plug insulators to become incandescent and to cause preignition when the switch is turned to the "OFF" position. Upon reaching the flight line the engine should be allowed to idle but a very short time upon the

set of plugs other than that used while taxiing. This procedure reduces the temperature of the hottest set of plugs before the switch is turned off.

e. As soon as the engine stops, turn off ignition switch.

f. Open throttle slowly, in order to reduce any tendency toward fire hazard due to leakage of gasoline from the carburetor.

IMPORTANT: By following the above cooling-off procedure, the possibility of "after-firing" is greatly reduced. The cylinder walls and pistons are also left in a well-lubricated condition, because the oil on them has cooled and does not drain off as readily as it does when an engine is stopped while at high operating temperatures. It is equally as important as the warm-up procedure in starting a cold engine. The subsequent warm-up is appreciably shortened and, because of the piston and cylinder wall lubrication remaining, the danger of loss of lubrication caused by overpriming is considerably reduced.

19. Check Before Leaving the Cockpit.

- a. Be sure the following are "OFF."
- (1) Fuel
 - (2) Throttle
 - (3) Ignition

(4) Carburetor air heater

(5) Cabin heat

(6) Communication equipment (model L-4A only)

b. Leave cushions and belts in order.

c. There are no parking brakes. Therefore arrange for tying down and/or chocking the wheels.

d. Note, preparatory to reporting, defects which developed in airplane during flight.

20. Maneuvers Prohibited.

It is not a matter of eliminating any particular maneuvers but of keeping in mind that the model L-4A and L-4B are light airplanes and should not be overtaxed as far as load factors are concerned. These airplanes are provided with an excess of control area in order to allow more complete handling at low speeds, thus avoiding accidents. However, this feature also enables the pilot to overcontrol at high speeds when performing aerobatics. A skillful pilot executes all maneuvers smoothly and avoids high speeds. The air speed should be kept below 90 mph and for snap rolls below 70 mph. When maneuvering, make the load as light as possible. Many stunts can be performed with safety with a light load which would be decidedly dangerous with a full load or overload. Do not make banks over 70 degrees. Do not let the airplane make "tail slides."

SECTION III
FLIGHT OPERATION DATA

This section contains the flight information charts and diagrams of value to the pilot. These are:

- | | |
|---|---|
| <p>1. Weight and Balance Diagram (figure 21).</p> | <p>2. Weight and Balance Chart.</p> <p>3. Specific Engine Flight Chart.</p> <p>4. Take-off, Climb, and Landing Chart.</p> |
|---|---|

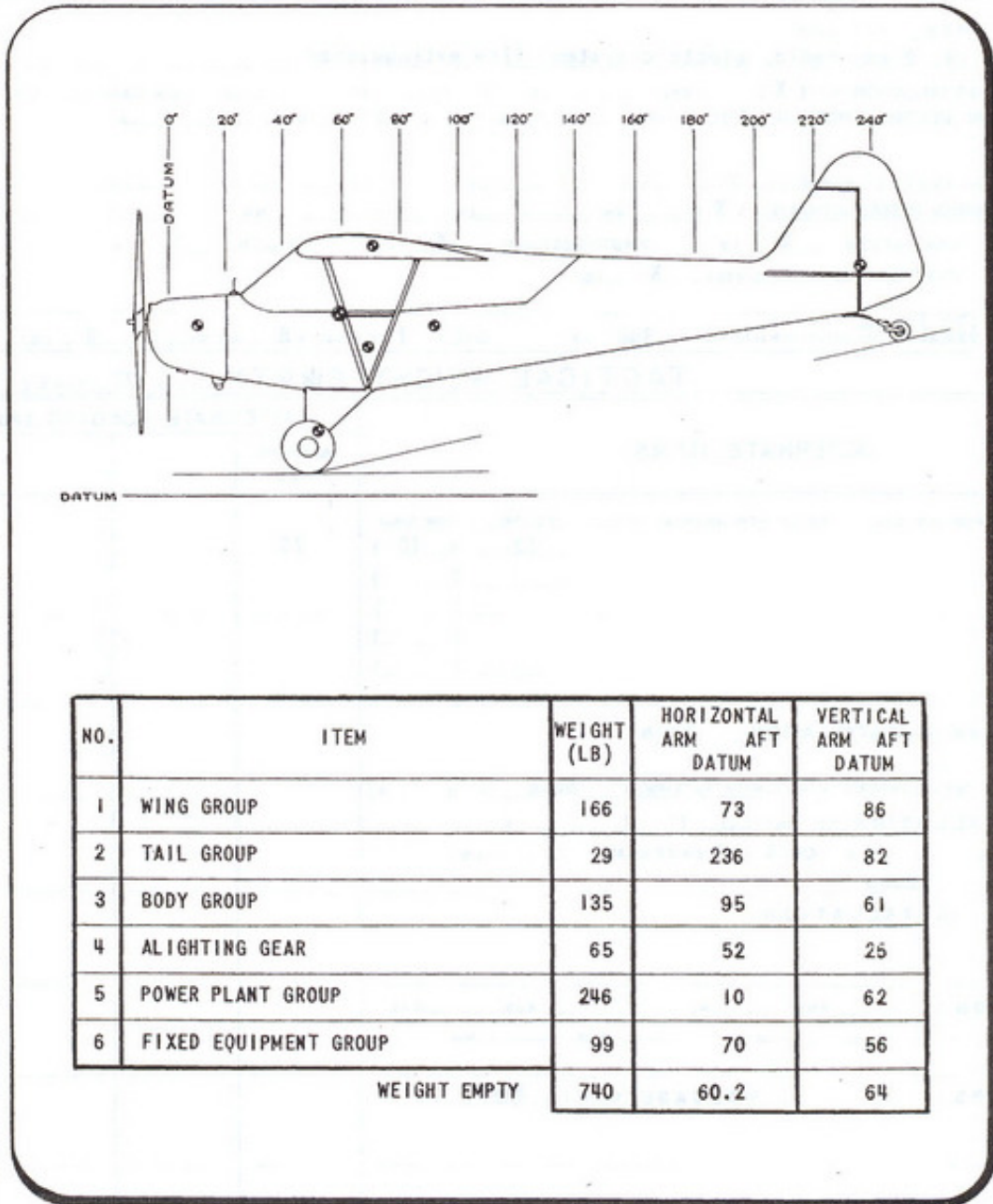

Figure 21 - Weight and Balance Diagram
for the Models L-4A and L-4B

WEIGHT & BALANCE CHART

AIRPLANE MODELS

L-4A

BALANCE (C.G.) LIMITS

CONDITION	PERCENT M.A.C.
TAKE-OFF	16.8% TO 36%
LANDING	16.8% TO 36%

BASIC LOAD ITEMS

POUNDS

WEIGHT EMPTY, (INCLUDING : Wood propeller, 2-way radio, electric system, fire extinguisher FIXED GUN INSTALLATION (S): (<input checked="" type="checkbox"/>) _____ CAL. _____ LB. () _____ CAL. _____ LB. GUN SIGHT. _____ LB. FIXED CANNON INSTALLATION(S): (<input checked="" type="checkbox"/>) _____ MM _____ LB. () _____ MM _____ LB. FLEXIBLE GUN INSTALLATION(S): (<input checked="" type="checkbox"/>) _____ CAL. _____ LB. () _____ CAL. _____ LB. FLEXIBLE CANNON INSTALLATION(S): (<input checked="" type="checkbox"/>) _____ MM _____ LB. () _____ MM _____ LB. EQUIPMENT: - NAVIGATION <input checked="" type="checkbox"/> LB. PHOTOGRAPHIC <input checked="" type="checkbox"/> LB. OXYGEN <input checked="" type="checkbox"/> LB. PYROTECNICS (FLARES ETC.) <input checked="" type="checkbox"/> LB.	740
CREW 2 ^{170 lb. ea.} (2 170 lb. ea. INCLUDING PARACHUTES) 340 LB. OIL (<u>1</u> U.S. GAL. = <u>8</u> IMP. GALL.) 8 LB.	348

TACTICAL WEIGHT EMPTY (C.G. 27 % M.A.C.)

ALTERNATE ITEMS

ALTERNATE LOADING (POUNDS)

	MAXIMUM FUEL			
FUEL (6 LB. PER. U.S. GAL. - 7.2 LB. PER IMPERIAL GALL) U.S. GAL. (IMP. GALL) <u>12</u> (<u>10</u>) _____ (_____) _____ (_____) _____ (_____) _____ (_____)	72			72
EXTRA TANK (S) INSTALLATION <u>None</u>				
EXTRA OIL (AS REQUIRED - MAXIMUM IS SHOWN) <u>None</u> G. (_____ G.)				
BOMB INSTALLATION (S): INTERNAL () _____ LB. () EXTERNAL _____ LB. OR () EXTERNAL _____ LB. <u>None</u>				
TORPEDO INSTALLATION <u>None</u>				
AMMUNITION : _____ RDS. _____ CAL. _____ RDS. _____ CAL. <u>None</u> _____ RDS. _____ MM _____ RDS. _____ MM				
PASSENGERS _____ BAGGAGE (MAX.) <u>None</u> LB.				

GROSS WEIGHT

NOTE: 1% M.A.C. = 0.61 INCHES	28%	BALANCE (IN PERCENT M.A.C.)	1160
-------------------------------	------------	-----------------------------	-------------

WEIGHT & BALANCE CHART

AIRPLANE MODELS

L-4B

BALANCE (C.G.) LIMITS

CONDITION	PERCENT M.A.C.
TAKE-OFF	16.8 % TO 36 %
LANDING	16.8 % TO 36 %

BASIC LOAD ITEMS

POUNDS

WEIGHT EMPTY, (INCLUDING : Wood propeller, fixed antenna, fire extinguisher	693
FIXED GUN INSTALLATION (S): (<input checked="" type="checkbox"/>) _____ CAL. _____ LB. () _____ CAL. _____ LB. GUN SIGHT _____ LB. FIXED CANNON INSTALLATION (S): (<input checked="" type="checkbox"/>) _____ MM _____ LB. () _____ MM _____ LB.	
FLEXIBLE GUN INSTALLATION (S): (<input checked="" type="checkbox"/>) _____ CAL. _____ LB. () _____ CAL. _____ LB. FLEXIBLE CANNON INSTALLATION (S): (<input checked="" type="checkbox"/>) _____ MM _____ LB. () _____ MM _____ LB.	
EQUIPMENT: - NAVIGATION <input checked="" type="checkbox"/> LB. PHOTOGRAPHIC <input checked="" type="checkbox"/> LB. OXYGEN <input checked="" type="checkbox"/> LB. PYROTECNICS (FLARES ETC.) <input checked="" type="checkbox"/> LB.	
CREW 2 ^{170 lb. ea.} 340 INCLUDING PARACHUTES) 340 LB. OIL (1 U.S. GAL. = 833 IMP. GALL.) 8 LB.	395

TACTICAL WEIGHT EMPTY (C.G. _____% M.A.C.)

ALTERNATE ITEMS

ALTERNATE LOADING (POUNDS)

MAXIMUM FUEL

FUEL (6 LB. PER U.S. GAL. - 7.2 LB. PER IMPERIAL GALL) U.S. GAL. (IMP GALL) <u>12</u> (<u>10</u>)	72			72
_____ (_____)				
_____ (_____)				
_____ (_____)				
_____ (_____)				
EXTRA TANK (S) INSTALLATION <u>None</u>				
EXTRA OIL (AS REQUIRED - MAXIMUM IS SHOWN) <u>None</u> G. (_____ G.)				
BOMB INSTALLATION (S): INTERNAL () _____ LB. () EXTERNAL _____ LB. OR () EXTERNAL _____ LB.				
<u>None</u>				
TORPEDO INSTALLATION				
<u>None</u>				
AMMUNITION: _____ RDS. _____ CAL. _____ RDS. _____ CAL. <u>None</u> _____ RDS. _____ MM _____ RDS. _____ MM				
PASSENGERS _____ BAGGAGE (MAX.) <u>None</u> LB.				
Portable Equipment _____				47

GROSS WEIGHT

NOTE: 1% M.A.C. = 0.61 INCHES	28%	BALANCE (IN PERCENT M.A.C.)	1160
-------------------------------	-----	-----------------------------	------

AIRPLANE MODELS		SPECIFIC ENGINE FLIGHT CHART							ENGINE MODELS					
L-4A and L-4B									0-170-3					
									MAX. PERMISSIBLE DIVING R.P.M. 2530					
									CONDITION ALLOWABLE OIL CONSUMPTION					
									"MAX CONTINUOUS" 0.21 IMP PT/HR. 0.13 U.S. QT/HR.					
									"ECONOMICAL MAX." X IMP PT/HR. X U.S. QT/HR.					
									"MIN. SPECIFIC" X IMP PT/HR. X U.S. QT/HR.					
									OIL GRADE: (S) 40/80 (W) 30/60					
									FUEL OCTANE 73					
									SUPERCHARGER TYPE: NONE					
CONDITION	FUEL PRESSURE LB./SQ. IN.	OIL PRESSURE LB./SQ. IN.	OIL TEMP. °C	OIL TEMP. °F	COOLANT TEMP. °C	Winter Oil	Summer Oil	MIXTURE CONTROL POSITION	FUEL FLOW (GAL./HR./ENG.) U. S.	IMP.	CYL. TEMP. °C	°F	MAXIMUM DURATION (MINUTES)	REMARKS
DESIRED	X	35	71	160	Air	SAE 30	SAE 40		5.8	4.7	288	550	15	
MAXIMUM	X	35	104	220	Cooled	or	or							
MINIMUM	X	20	49	120	Cooled	Avia.	Avia.	X	4.27	3.6	288	550		
IDLING	X	10	49	120	Cooled	60	80	X	3.37	2.8	288	550		
OPERATING CONDITION	R.P.M.	MANIF. PRESS. (BOOST)	HORSE POWER	CRITICAL ALTITUDE (FEET)	USE LOW BLOWER BELOW									
TAKE-OFF	2300	X	65	Sea Level	X FT. ALT.			X						
EMERGENCY MAXIMUM					FT. ALT.									
MAXIMUM CONTINUOUS	2100	X	50	Sea Level	X FT. ALT.			X						
ECONOMICAL. MAXIMUM	2000	X	48	Sea Level	X FT. ALT.			X						
MINIMUM SPECIFIC CONSUMPTION														
MINIMUM CRUISING														
CONDITIONS TO AVOID														
NOTE: CRITICAL ALTITUDE IS THAT AT WHICH MAXIMUM POWER IS OBTAINED WITH FULL THROTTLE UNDER CONDITIONS SHOWN.														

ENGINE MODELS

0-170-3

TAKE-OFF, CLIMB & LANDING CHART

AIRPLANE MODELS

L-4A and L-4B

TAKE-OFF DISTANCE (IN FEET)

GROSS WEIGHT (IN LBS)	HEAD WIND (MPH)	HARD SURFACE RUNWAY				SOD - TURF RUNWAY				SOFT SURFACE RUNWAY					
		AT SEA LEVEL		AT 3,000 FT.		AT SEA LEVEL		AT 3,000 FT.		AT SEA LEVEL		AT 3,000 FT.		AT 6,000 FT.	
		GROUND RUN	TO CLEAR 50' OBJ.	GROUND RUN	TO CLEAR 50' OBJ.	GROUND RUN	TO CLEAR 50' OBJ.	GROUND RUN	TO CLEAR 50' OBJ.	GROUND RUN	TO CLEAR 50' OBJ.	GROUND RUN	TO CLEAR 50' OBJ.	GROUND RUN	TO CLEAR 50' OBJ.
1160	0	350	737	470	990										
	20	175	370	235	490										
	40														
	0														
	20														
	40														

NOTE: INCREASE DISTANCE 10% FOR EACH 10°C (50°F) ABOVE 0°C (32°F)

ENGINE LIMITS FOR TAKE-OFF RPM B IN. HG

CLIMB DATA

GROSS WEIGHT (IN LBS)	TYPE OF CLIMB	COMBAT MISSIONS USE 2300 RPM B -----IN. HG				FERRY MISSIONS USE 2300 RPM B -----IN. HG			
		S. L. TO 5000 FT. ALT.		FT. ALT.		S. L. TO 5000 FT. ALT.		FT. ALT.	
		BEST I.A.S.	TIME FROM S.L.	BEST I.A.S.	FUEL FROM S.L.	BEST I.A.S.	FUEL FROM S.L.	BEST I.A.S.	FUEL FROM S.L.
1160	COMBAT FERRY	55	333	15 min					
	COMBAT FERRY	55	333	15 min					
	COMBAT FERRY								
	COMBAT FERRY								

NOTE: INCREASE ELAPSED CLIMBING TIME % FOR EACH 10°C (50°F) ABOVE 0°C (32°F) FREE AIR TEMPERATURE. FUEL INCLUDES WARM-UP AND TAKE-OFF ALLOWANCE

LANDING DISTANCE (IN FEET)

GROSS WEIGHT (IN LBS)	BEST I.A.S. APPROACH	HARD DRY SURFACE				FIRM DRY SOD				WET OR SLIPPERY					
		AT SEA LEVEL		AT 3,000 FT.		AT SEA LEVEL		AT 3,000 FT.		AT SEA LEVEL		AT 3,000 FT.		AT 6,000 FT.	
		TO CLEAR 50' OBJ.	GROUND ROLL	TO CLEAR 50' OBJ.	GROUND ROLL	TO CLEAR 50' OBJ.	GROUND ROLL	TO CLEAR 50' OBJ.	GROUND ROLL	TO CLEAR 50' OBJ.	GROUND ROLL	TO CLEAR 50' OBJ.	GROUND ROLL	TO CLEAR 50' OBJ.	GROUND ROLL
1160	60	605	350												

NOTE: FOR GROUND TEMPERATURES ABOVE 35°C (95°F) INCREASE APPROACH I.A.S. 10% AND ALLOW 20% INCREASE IN GROUND ROLL.

REMARKS

LEGEND
I.A.S. - INDICATED AIR SPEED
NOTE: ALL DISTANCES ARE AVERAGE, AND SUBJECT TO CONSIDERABLE VARIATIONS BECAUSE OF DIFFERENCES IN PILOT TECHNIQUE, LOAD, C.G., ETC.
RED FIGURES HAVE NOT BEEN FLIGHT CHECKED.

SECTION IV

OPERATIONAL AND ELECTRICAL EQUIPMENT (Model L-4A Only)1. Communication Equipment and Operation.a. The Communication Equipment.

(1) Radio receiver is mounted on the upper left side of cockpit near wing root, tilted for operator's convenience. (See figures 11 and 22.) It contains a jack for the headphone.

(2) Transmitter system includes:

(a) Radio transmitter which is mounted on top of desk at rear of cockpit. (See figures 1, 3, 14, and 22.) Its fuse protects all radio equipment.

(b) Transmitter remote control panel, which is mounted on the upper left side of cockpit aft of the receiver. (See figures 11 and 22.) Microphone can be plugged into its jack or the jack on the transmitter.

(c) Two cards, the transmitter tuning chart and operating instructions, in holders fastened on observer's desk beside transmitter. (See figure 14.)

(3) Antenna system includes:

(a) Drag unit, at the top of rudder. (See figures 3 and 22.)

(b) Antenna reel, at the upper left side of cockpit aft of transmitter remote control panel. (See figures 1, 11, and 22.)

(c) Entrance fair-lead, from reel to exterior of cockpit. (See figures 3, 11, and 22.)

(d) Retractable trailing antenna wire, from reel to drag unit, with a fully extended length of 125 feet. (See figures 3, 11, and 22.)

b. Operation.

(1) The above units comprise the complete aircraft communication installation for communication from the aircraft to ground stations or to other aircraft. The equipment is simple and direct in operation.

(2) When the antenna is reeled in, it constitutes a fixed antenna. Crank clockwise, in flight only, to play out antenna. Observe transmitter tuning chart to determine number of turns required for frequency in use. (See figure 14.)

(3) CAUTIONS:

(a) The transmitter must not be operated in a hangar, while the airplane is being fueled, or near fuel supplies.

(b) To avoid the possibility of the microphone cord becoming entangled with the airplane controls, make sure the microphone is

hung upon the hook when not in actual use.

(c) Be sure that the antenna is clear of any airplane or structure which might act as a ground when testing the radio before flight.

(d) Be sure to reel in antenna wire before landing.

(4) The steps of recommended operation may be found on the card beside the transmitter. They are as follows:

(a) Plug headphones and microphone in respective jacks.

(b) Throw airplane's master battery switch to "ON" position.

(c) Turn receiver on by rotating volume control clockwise.

(d) Set VAR.-CRYSTAL switch to variable tuning. Crystal tuning is available only when crystals are used in receiver.

(e) Tune receiver carefully to desired signal. The use of CW (telegraph) position is very helpful in spotting desired signal when waiting for desired signal to appear.

(f) For CW reception throw CW-PHONE switch to CW; for phone reception throw CW-PHONE switch to PHONE.

(g) To operate transmitter throw ON-OFF switch on either remote control panel or transmitter to "ON" position. Jewel lights on remote control panel and transmitter panel should glow indicating that transmitter is on. Receiver must be on before transmitter can be turned on.

(h) Allow 30 seconds for filaments to warm up.

(i) Set controls on transmitter and antenna length for desired frequency and selected operation as indicated on TUNING CHART.

(j) Press microphone button and talk directly into front of microphone with lips just touching mouthpiece.

(k) To turn transmitter off, reverse above procedure. Receiver and transmitter can both be turned off by means of receiver volume control.

(l) Master battery switch must always be turned off before leaving airplane.

NOTE: Antenna current must always register on meter when transmitting. Failure to do so may be caused by improper adjustments, especially with transmitter

TUNING control being set too sharp (too much towards the low-number side). Always use antenna length which gives highest reading on meter after other controls are set according to tuning chart. For further information, see instruction book.

2. Electrical Equipment.

a. Six-volt battery, in metal case, is located on the center of the floor forward of cockpit. (See figure 16.)

b. Master fuses, and spares, 25 amperes, are on the battery box.

c. Battery-condition indicator is at the extreme left on instrument panel board. (See figure 3.) Switch on generator if instrument indicates battery is below normal. Switch off generator if battery is above normal. When operating with generator off, the indicator

will show approximately half scale if battery is fully charged.

d. Master switch ("OFF" backward and "ON" forward) is located to the right in the rear of front seat on floor board. (See figures 6 and 16.) This switch controls the electrical supply from the battery. It does not control the magnetos. Keep "OFF" when radio equipment is not in actual use.

e. Generator switch is mounted on same bracket with master switch. (See figures 6 and 16.) Observe placard mounted on floor board alongside junction box.

NOTICE: Be sure generator control switch reads "OFF" when operating below cruising speed (70 mph) or when standing on ground.

f. Generator, wind driven, is located directly below the fuselage on cabane vee of landing gear. (See figures 1 and 3.)

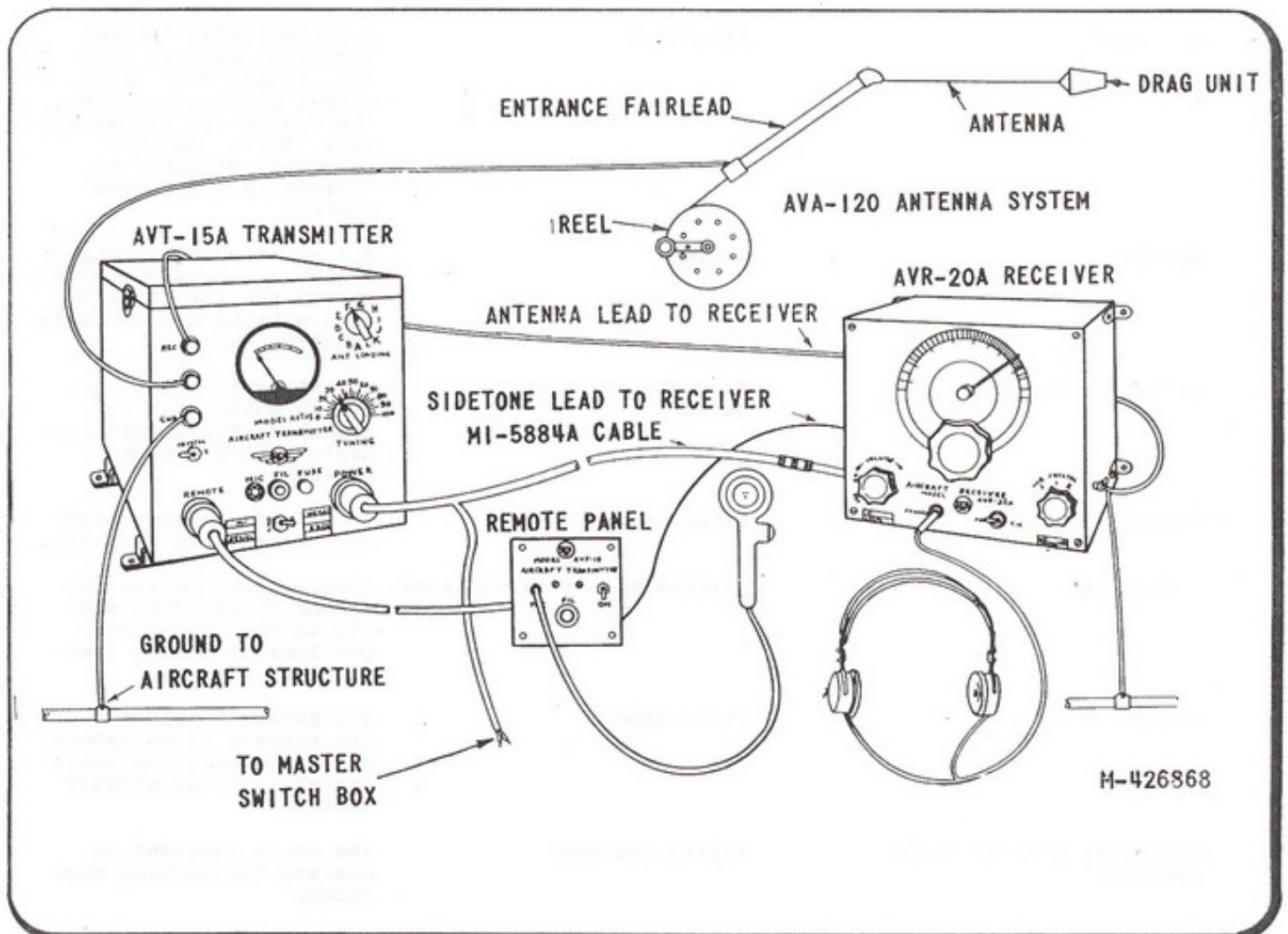

APPENDIX IABRIDGED UNITED STATES-BRITISH GLOSSARY OF NOMENCLATURE
(Extracted from master glossary)

<u>American</u>	<u>British Equivalent</u>	<u>Definition</u>
Aircraft	Aircraft	Any weight-carrying device designed to be supported by the air, either by buoyancy or by dynamic action. In Britain used only as a collective plural, and in the United States as either a singular or a collective plural.
Aircraft, heavier-than-air, or aerodyne	Aerodyne	A generic term for aircraft which derive their lift in flight chiefly from aerodynamic forces.
Airdrome, air field, or airport	Aerodrome	A definite and limited area of ground or water intended to be used in connection with the arrival, departure, and servicing of aircraft.
Airplane	Aeroplane	A mechanically driven aircraft, heavier than air, fitted with fixed wings, and supported by the dynamic action of the air. Note: Curtiss Aeroplane Division is correct in the United States.
Antenna	Aerial	A conductor consisting of a wire or wires supported in the air for directly transmitting or receiving electric waves.
Battery, storage	Accumulator or storage battery	A battery of leakproof design which will not discharge its liquid contents during violent maneuvers.
Cabane	Cabane or pylon	A pyramidal arrangement of struts on an airplane.
Carburetor	Carburettor or carburetter	A mechanical device for mixing liquid fuel and air in the proper proportions to form a combustible mixture.
Chord	Chord line	The straight line through the centers of curvature of the leading and trailing edges of an airfoil section.
Controls, air, or cable controls	Flying controls	The means employed to operate the control surfaces.

<u>American</u>	<u>British Equivalent</u>	<u>Definition</u>
Course	Track-angle	The direction over the surface of the earth, with respect to true north, that an aircraft is flown.
Course or track	Track	The projection of the path of the center of gravity of an aircraft onto the earth's surface.
Course made good or true course	True track-angle	The true direction the aircraft bears from the point of departure.
Cowling (cockpit) or cockpit enclosure	Cockpit enclosure	A removable covering around and over a cockpit.
Distance, take-off	Take-off run	The distance in which an airplane will finally break contact with land or water, starting from zero speed.
Drift	Drift-angle	The angle between the heading and the track.
(to) Dump or jettison	(to) Jettison, slip, or dump	To release material from an aircraft in danger of being lost or wrecked.
Efficiency, propeller	Net efficiency	The ratio of the thrust power to the input power of a propeller.
Engine	Aero-engine	An engine used to provide the motive power for an aircraft.
Exit	Egress or exit	A passage out of a place.
Field, landing	Landing ground	A field of such a size and nature as to permit of aircraft landing and taking off in safety.
Filter, screen, or strainer (oil)	Filter	A porous material or a unit through which engine oil is passed to cleanse and strain it.
Filter, air	Air cleaner	A porous, usually oil soaked material through which air is passed to remove dust and sand.
Flow, streamline	Streamline motion	The steady motion of a fluid past an obstacle when the paths of all particles contain neither abrupt changes in direction nor closed curves.
Flying, blind, or instrument flying	Instrument flying	The act of flying an aircraft solely by instruments.
Gage, fuel, or fuel gage	Fuel-contents gauge or fuel level indicator	A gage for indicating the quantity of fuel in a fuel tank.

<u>American</u>	<u>British Equivalent</u>	<u>Definition</u>
(to) Gall or fret	(to) Fret	To damage or wear by an oscillating motion, as in the case of splines.
Gasket	Joint, washer, or gasket	A sheet or ring of packing used for pipe joints, engine heads, and similar purposes.
Gasoline, "gas," or fuel	Petrol or fuel (preferable)	A volatile, inflammable, liquid hydrocarbon mixture used as a fuel.
Gear, landing, or undercarriage	Alighting gear, undercarriage, or chassis	The understructure which supports the weight of an aircraft when in contact with the surface of the land or water and reduces the shock on landing.
Generator	Dynamo	A machine by which mechanical energy is changed into electrical energy.
Ground	Earth or ground	The connection made in grounding an electrical circuit.
Head, air speed	Pressure head	An instrument which in combination with a gage is used to measure the speed of an aircraft relative to the air. It usually consists of a pitot static tube or a pitot venturi tube.
Heading	Course	The angular direction of the longitudinal axis of an aircraft with respect to true north.
Hood	Bonnet	Removable metal covering over the engine.
Interphone	Intercommunication	A system of communication between different stations on the same aircraft.
Kerosene or coal oil	Paraffin, kerosene, or petroleum	An illuminating oil distilled from petroleum.
(to) Land	(to) Alight	To come to the ground or the surface of the water.
Lean	Weak	Of a mixture of air and gasoline vapor, deficient in the gasoline vapor.
Left	Port	Situated to the left, looking in the direction of motion of an aircraft.
Length, chord	Chord or chord length	The length of that part of the chord which is intercepted by the airfoil section.

<u>American</u>	<u>British Equivalent</u>	<u>Definition</u>
(to) Level off	(to) Flatten out	To make the flight path of an airplane nearly horizontal before making contact with the earth.
Lift, useful	Disposable lift	The lift available for carrying fuel and oil, passengers, cargo, food and drinking water, guns, ammunition, and bombs.
Load, pay	Pay load or commercial load	That part of the useful load from which revenue is derived; that is, passengers, mails, and freight.
Loop, normal	Loop	A loop starting from normal flight and passing successively through a climb, inverted flight, dive, and back to normal flight.
Loop, outside	Inverted loop or outside loop	A loop starting from normal flight and passing successively through a dive, inverted flight, climb, and back to normal flight, the pilot being on the outside of the flight path.
Maneuverability	Maneuverability or manoeuvrability	That quality in an aircraft which determines the rate at which its altitude and direction of flight can be changed.
Muffler	Silencer	A tube, sometimes containing baffles, through which the exhaust gases of an internal-combustion engine are passed.
Navigation, air	Avigation	The guidance of craft through the air in accordance with previous calculations. "Avigation" has been used, but is considered unnecessary in the United States.
(No equivalent)	Ditching	The forced descent of land planes at sea.
Oil, slushing, or slushing compound	Corrosion inhibitor	A semi-solid oil or grease used as a protective coating for bright metal surfaces.
Operator, radio	Wireless operator	The operator of a radio sending and receiving set.
Overload	Non-standard load or overload	A load in excess of the permissible flying load under the prevailing regulations.

<u>American</u>	<u>British Equivalent</u>	<u>Definition</u>
Pan, oil	Crankcase sump	That portion of the crankcase in which lubricating oil is collected and led to the oil-pumping system. Refers usually to in-line engines.
Panel, center wing, center of inboard panel, or center section	Centre section plane or centre section	The central unit of a wing surface.
Panel, outboard	Outer plane	The outer unit of a wing surface.
Pin, piston, or wrist pin	Gudgeon pin or piston pin	A round shaft used in the pin bearing connection between the piston and connecting rod.
Plug or attachment plug	Plug	A removable male fitting for making electrical connections by insertion in a receptacle or body.
Plug, spark	Spark plug	A unit holding the positive and negative electrodes which form the spark gap in a combustion chamber.
(to) Prime	(to) Prime or dope	To operate a pump which squirts raw gasoline into the intake passages or cylinders to facilitate starting.
Propeller	Airscrew (obsolete), propeller, or propeller	A power-driven bladed screw designed to produce thrust by its rotation in air.
Reel	Winch or reel	A device for winding in an antenna, cord, or rope.
Rib, false, or former rib	Nose rib	A rib between the front spar and leading edge of an airfoil.
Right	Starboard	Situated to the right, looking in the direction of motion of an aircraft.
Roll, snap	Flick roll	A rapidly executed roll.
Runway or landing strip	Runway	An orientated path within the effective landing area along which aircraft arrive and depart.
Set, command	Pilot controller set	A radio set tuned to a fixed frequency of the command base.
Set, liaison	General purpose set	A general purpose radio sending and receiving set.
Socket, plughole, or jack	Socket	A fixed female fitting for making electrical connections by the insertion of a plug.

<u>American</u>	<u>British Equivalent</u>	<u>Definition</u>
Sock, wind, or wind cone	Wind cone, wind sleeve, or wind sock	A fabric of conical section, vented at the apex, and used to determine wind direction because of its pivot mounting.
Speed, calibrated air	Indicated air speed (A.S.I.)	The reading of the air speed indicator, corrected for instrumental and installation errors.
Speed, critical, or stalling speed	Stalling speed	The lowest speed of an aircraft at which control can be maintained.
Speed, indicated air (IAS)	Air speed indicator reading	The reading of the air speed indicator.
Speed, minimum	Minimum flying speed	The minimum air speed at which an airplane can be maintained in level flight.
Speed, rated engine	Maximum rpm for continuous cruising	The highest speed of an engine at which its reliability has been determined for continuous performance.
Spiral	Spiral glide	A banked continuous gliding turn.
Stabilizer or horizontal stabilizer	Tail plane	A fixed surface forming part of the empennage to increase longitudinal stability.
Stabilizer, vertical, or tail fin	Fin	A fixed surface approximately parallel to the plane of symmetry, affecting the lateral stability of the motion of an aircraft.
Stream, slip, or propeller race	Slipstream	The stream of air driven aft by the propeller.
Surface, aerodynamically balanced, or balanced surface	Balanced surface	A control surface in which the aerodynamic moments about the hinge are wholly or partly self-balanced.
Tachometer	Engine speed indicator (E.S.I.), tachometer, revolution indicator, or rev. counter	An instrument which measures revolutions per minute of an airplane engine.
Test, block	Test after overhaul	The test given an airplane engine generally after overhaul but before installation in the airplane.
Thrust, propeller	Airscrew thrust (obsolete) or propeller thrust	The component parallel to the propeller axis of the total air force on the propeller. Its symbol is T.

<u>American</u>	<u>British Equivalent</u>	<u>Definition</u>
Tire	Tyre or tire	A pneumatic rubber container around the circumference of a wheel which serves to reduce vibration and shock.
Tube	Valve	A radio electron tube.
Valve	Cock or valve	Any device by which the flow of liquid or gas may be started, stopped, or regulated.
Vent	Vent-pipe	A pipe leading from the air space in a fuel, oil, or coolant tank to the atmosphere.
Vise or vice	Vice	A device having two jaws closed by a screw to hold work.
Wash or wake	Wake	A disturbance in air produced by the passage of a body.
Weight, empty, or dead load	Tare weight or tare	The weight of an aircraft complete in flying order, but with no crew, fuel, oil, removable equipment, or pay load.
Weight, fixed power plant	Gross dry-weight	Weight of the power plant and its accessories, exclusive of fuel and oil and their tanks.
Weight, gross, or full load	Gross weight or all-up weight	The maximum permissible flying weight of an aircraft under the prevailing conditions.
Windshield	Windscreen	A shield of glass or other transparent material to protect the pilot from wind and rain.
Wing	Main plane	The whole or a portion of the main supporting surfaces of an airplane.
Wire, lock, or safety wire	Safety wire	A wire used to secure a small part so that it cannot loosen.
Wrench	Spanner or wrench	An instrument for exerting a twisting load, as in turning bolts or nuts.